

MEASUREMENT & CONTROL OF PARTICLE-BEAM TRAJECTORIES IN THE ADVANCED PHOTON SOURCE STORAGE RING

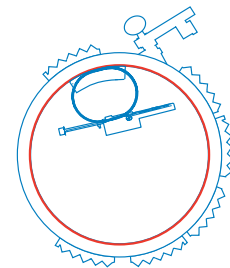

Glenn Decker *Accelerator Systems Division, Argonne National Laboratory*



In order to provide Advanced Photon Source (APS) users with stable x-ray beams, it is necessary that undesirable beam motions be eliminated at the source, i.e., from the positron beam in the storage ring. This article is a review of the stability objectives, position measurement techniques and capabilities, and AC and DC orbit servo techniques used at the APS. A summary of performance to date is given, along with a brief discussion of the performance limitations of the present system and upgrade plans for improving upon these limits.

STABILITY SPECIFICATIONS

The orbit stability requirements for the APS storage ring were specified during the accelerator-design phase. In order to provide stable x-ray beams, the rms beam motion must be less than 5% of the particle-beam dimensions at the source point. For insertion device sources, given the design values for ring emittance and coupling, this requirement is summarized as:

$$\Delta x < 17.3 \text{ mm rms}, \Delta x' < 1.22 \text{ } \mu\text{rad rms}$$

$$\Delta y < 4.5 \text{ mm rms}, \Delta y' < 0.45 \text{ } \mu\text{rad rms}$$

where Δx and $\Delta x'$ are the tolerances for horizontal displacement and angular motion, respectively, and Δy and $\Delta y'$ are the corresponding vertical tolerances. Keep in mind that the thickness of a human hair is typically about $50 \text{ } \mu\text{m}$. Note also that the position and angle tolerances in general are not independent quantities; a relation can be derived from the magnetic lattice to show that the ratio of the rms position and angle motion is fixed for noise sources occurring randomly around the ring.

ORBIT MEASUREMENT¹

The primary diagnostic used for control of the orbit in the APS storage ring (large photo above) are the radio frequency (rf) beam position monitors (Fig. 1 next page), commonly referred to as rf BPMs. Capacitive button pickup electrodes mounted on the

vacuum chamber (circular photo above) provide signals to in-tunnel differencing/filtering electronics. These "filter-comparator" units transmit rf frequency difference and sum signals derived from the four buttons at each of 360 rf BPM stations to rf monopulse receivers ("amplitude to phase," or AM-PM converters) placed on top of the storage ring tunnel enclosure and connected using low-loss coaxial cables (Andrews FSJ1-50 heliax). The monopulse receivers effectively normalize these signals (difference/sum), supplying video bandwidth ($\sim 10 \text{ MHz}$) signals to the digitizer, which are proportional to transverse beam position. Beam position information is digitized once per turn with 12 bits of resolution.

Following digitization, the data are averaged both with hardware circuitry and special software that runs in a nearby Experimental Physics and Industrial Control System (EPICS) input/output controller (IOC). The result is a measure of beam position with submicron resolution, albeit with very limited bandwidth. Typically, the computer-driven orbit control algorithms will eliminate orbit "drift" with variations slower than some tens of seconds. Beam jitter is removed using the real-time orbit feedback system, described below. The real-time system makes use of the same position information, but without any EPICS software averaging, instead having its own hardware averager.

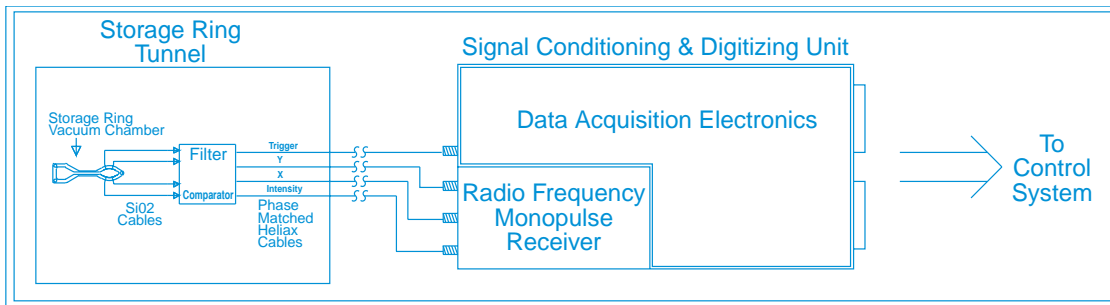

FIG. 1. Block diagram of the APS storage ring beam position monitor system.

DC ORBIT CONTROL²

Once the 720 pieces of beam position information (360 in each plane) are available to EPICS, a sophisticated software algorithm uses them to compute corrections to apply to the control setpoints of a subset of the 317 available combined function horizontal/vertical corrector magnets. Essentially, the change in position Δx at each of the 360 BPM stations is related to the change in the vector of 317 corrector settings ΔC_x via a rather large, unsymmetrical response matrix \mathbf{R} as follows:

$$\mathbf{R} \Delta C_x = \Delta x,$$

and similarly for the vertical plane. In principle, one can simply invert the matrix, which is straightforward given available algorithms like singular value decomposition, and send a resultant vector of corrector setpoints in such a way as to minimize the rms of the readbacks from the 360 BPMs.

Practically speaking, it is most difficult to perform useful correction of slow orbit drift, primarily as a result of very small but significant systematic errors. The systematic errors faced by the APS orbit control system are typically on the scale of tens of microns, derived both from mechanical sources, such as the response of the vacuum chamber to temperature changes, and from variations in the properties of the processing electronics resulting from changes in beam intensity, temperature, etc.

To compensate for these systematic errors, several things are done inside the DC orbit-correction algorithm. Only a small number of correctors are chosen, typically about 60 out of the 317 possible, while as many BPM readbacks as possible are used for global correction. The remainder of the correctors that are not used for DC orbit correction are generally used for local beamline steering, which is done infrequently. Overdetermining the orbit correction in this manner has the result of correcting very efficiently long spatial wavelength (i.e., physical) beam motions while tending to ignore the unit-to-unit variations typically associated with systematic effects. Shown in Fig. 2 is a typical display containing horizontal and vertical beam position data, actually a difference measured relative to a reference data set. Note that the beam motion generally has a

strong 35th harmonic in the horizontal plane and a longer wavelength 14th harmonic in the vertical, corresponding to the machine tunes of 35.2 and 14.3, respectively. Note also the presence of a small number of data points that do not fit the curve. These represent the types of systematic errors with which the orbit correction must deal. The benefit of taking advantage of statistics by using large numbers of BPMs cannot be overstated. Small systematic errors are reduced significantly in terms of their effect on real beam motion.

A “de-spiking” algorithm is used to eliminate suddenly misbehaving BPMs, or those which drift excessively, as demonstrated by Fig. 2. The erroneous readback is replaced by the average of neighboring units, which is made possible by the high density of BPMs around the ring. This avoids the necessity of recomputing the inverse response matrix, which, while formally more correct, requires interrupting the correction process so that new parameters may be calculated. Typically, any BPM whose “error” readback varies by more than 20 microns from neighboring units gets de-spiked. (A BPM error in this context has the connotation of being the deviation of a readback from its setpoint.)

Recall that the BPM electronics are self-normalizing, i.e., their readback is designed to be independent of the amount of beam stored. While this normalization is done with good accuracy, it is still

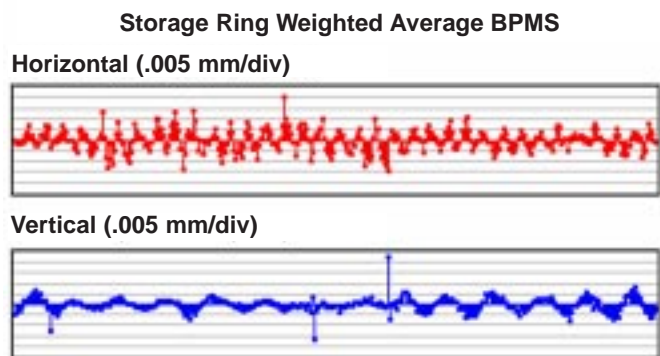

FIG. 2. Difference orbit showing typical global beam motion and systematic error effects. The vertical scale is $5 \mu\text{m}/\text{division}$.

not quite good enough. In fact, variations in position readback are seen at the tens of microns level in the absence of any true beam motion. This is characteristic of most rf BPM systems—systematic intensity compensation is routinely performed at the European Synchrotron Radiation Facility (ESRF), for example, to correct errors of magnitude similar to what is experienced at the APS.³ The variation in position with beam intensity is eliminated by a separate computer program that subtracts previously measured offset vs. intensity data from the position readbacks to provide a true, or adjusted, readback that is then fed into the orbit-correction algorithm.

A separate type of correction is now performed routinely that does not involve the steering corrector magnets at all. Twice a day, as the moon passes overhead (or underfoot), the circumference of the storage ring changes by about thirty microns due to Earth tides. In order to compensate for this, the frequency of the rf system is adjusted to regulate the orbit circumference. If left uncorrected, this effect would impact horizontal beam position in bending magnet beamlines.

AC ORBIT CONTROL⁴

An elaborate real-time feedback system has been implemented at the APS to handle AC orbit correction (Fig. 3). The system is all digital and relies on a distributed array of digital signal processors (DSPs) to perform corrections to the orbit at a 1-kHz rate. Digital data are sent directly from the BPM electronics to a crate of processing electronics. These data are then distributed to 20 other crates around the ring in real time by a dedicated fiber-optic network using a piece of hardware called a “reflective memory.” All local feedback crates thus have access to global data. The correction proceeds in much the same way as for the DC correction, but at a much faster data rate. Digital signal processors multiply columns of an inverse response matrix by the real-time position data to arrive at steering corrector setpoints. These setpoints are then digitally filtered to avoid overlapping the correction bandwidth of the DC correction and to optimize performance up to 30 Hz. The strategy used by the AC feedback is similar to the one used for DC correction in that a large number of BPMs (160) and a relatively small number of correctors (38 in each plane) are employed. Here the limitation on the number of BPMs is a matter of DSP processing speed.

One advantage that the real-time system has over the DC orbit correction is that the systematic errors are much less severe since the real-time system in its present implementation explicitly does not perform DC corrections. Thus, long-term drift effects are of much less importance. Strategies for dealing with systematic errors and malfunctioning BPMs are still under development. These are pri-

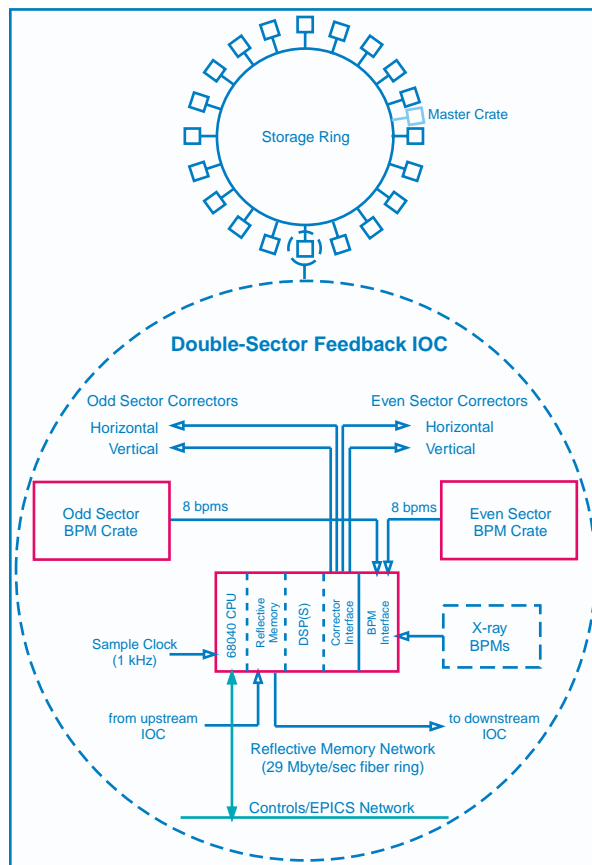

FIG. 3. Block diagram of the APS real-time closed-orbit feedback system.

marily a reliability issue for the system in terms of degraded beam parameters when the system must be turned off for reconfiguration to remove any malfunctioning BPMs from the algorithm.

In addition to reducing beam jitter, the real-time feedback has proven to be an extremely powerful tool in the effort to localize and eliminate noise sources. This is now beyond proof of principle—studies shifts have been routinely scheduled with the express purpose of tracking down, for example, noisy power supplies, which are then repaired. Transient noise sources, which are notoriously difficult to identify let alone eliminate, can be routinely monitored with the feedback system. The evidence is very promising that this technique will ultimately provide the lowest possible ambient noise level in the beam.

SYSTEM PERFORMANCE⁵

The result of orbit correction efforts to date are summarized in Figs. 4, 5, and 6. Figures 4 and 5 show power spectral densities for horizontal and vertical beam motion, respectively. Each spectrum is the average of data from 40 beam position monitors located near insertion device source points. The dimensions (mm^2/Hz) may be unfamiliar to some; however, the interpretation can be understood by recognizing that the area under the curve (on a lin-

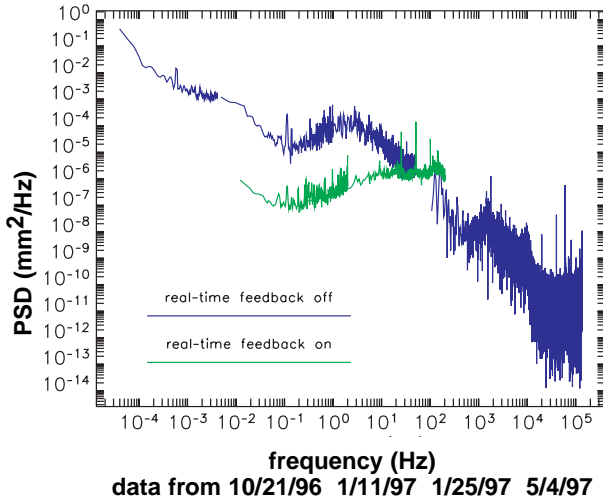

Fig. 4: APS horizontal beam-motion power spectral density at insertion device source points.

ear scale) yields the mean square beam motion. Notice that nearly ten decades of frequency are encompassed in the plots, ranging from data acquired over a 14-hour fill (2×10^{-5} Hz) all the way up to 135 kHz, which is the Nyquist frequency for data sampled once per revolution. The spectral peak at 0.0005 Hz corresponds to a 30-minute water temperature cycle. Between 0.1 and 0.2 Hz are two lines: one is the DC orbit correction sending corrections to the power supplies every ten seconds or so, and the other is the intensity dependence correction software. The narrow lines at 25, 50, and 75 Hz were traced to an unstable quadrupole magnet power supply, which has since been repaired. At 1.7 kHz, one can see the synchrotron tune — evidence of frequency modulation, i.e., variations in the beam’s revolution period. Finally, the lines at 20, 40, and 60 kHz correspond to the ubiquitous power supply “chopper noise” resulting from the pulse-width modulation regulators used for nearly all storage ring magnets.

The effects of the real-time feedback are clearly shown. It has the largest effect in the band ranging from a fraction of a Hz up to about 30 Hz, where a majority of the orbit motion occurs. Note that the very-low-frequency components, in addition to being the largest (in density), are also the most difficult to measure (it takes hours or even days) and are similarly very difficult to correct. Having said that, the progress in fill-to-fill and day-to-day orbit reproducibility has been very good, typically better than 10 microns rms vertically and similarly in the horizontal plane.

Shown in Fig. 6 is a more pedestrian view of the rate of improvement of orbit stability in the APS storage ring. Here the vertical axis corresponds to the rms beam motion in the band from 0.01 Hz up to 30 Hz, as a function of time measured by opera-

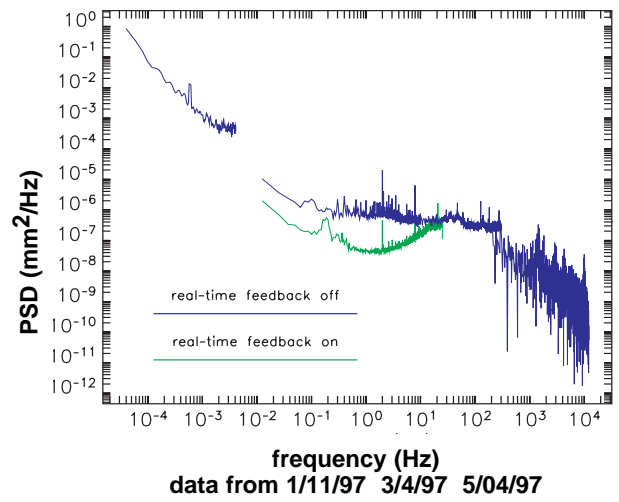

Fig. 5: APS vertical beam-motion power spectral density at insertion device source points.

tional run number. This is plotted both with and without the real-time feedback system operating, with the specifications indicated.

LIMITATIONS AND PERFORMANCE UPGRADES

The rf BPM system at the APS is now entering a mature phase of operation in which the hardware is essentially understood and planning to improve performance has begun. The system was designed to have broad-band turn-by-turn measurement capability to facilitate commissioning (for which it functioned very well) and provide postmortem analyses for extremely fast beam loss events (for which it also has been very useful). A system of this type results in a certain set of operational constraints and types of systematic errors. The bunch pattern is of critical importance to the operation of such a system and, as is commonly known, this has unfortunately placed constraints on what bunch patterns can be used at the APS. Specifically, a 1- μ s or greater dead-time in the fill pattern is needed to allow the rf front-end bandpass filters to “ring-down” to a level where they do not impact the measurement of bunches that follow. One ongoing effort is to redesign these filters to allow bunch (or cluster) spacing as close as 100 ns. It is understood what is required to achieve this, and prototype configurations are under test.

As mentioned earlier, the AC orbit feedback now operates up to ~ 30 Hz. Plans are in the works for additional processing power to effectively raise the sampling rate from 1 kHz up to 2 kHz. This will allow access to more BPM data while achieving a higher correction bandwidth. Ultimately the identification and elimination of noise sources greater than about 60 Hz will be our most effective strategy for very high frequencies, using the feedback system itself as a diagnostic.

Another major effort in progress uses narrow-band “switched-receiver” electronics attached to pickup electrodes mounted on the small-gap insertion device vacuum chambers. The idea here is to rapidly switch (~ 10 kHz) each of the four pickup electrodes in turn through a common narrow-band heterodyne receiver, thus eliminating systematic errors associated with attempting to match sets of receiver electronics. These are expected to have improved performance in terms of systematic effects for DC correction. A complete production set of these receivers, including all of the data acquisition hardware, is under test at an unused insertion device location, and components to instrument all existing insertion devices are on order. These receivers will have their own set of systematic effects requiring study to achieve true submicron stability. This effort is already under way.

Nothing has been said thus far about the x-ray beam position monitors (X-BPMs). These are presently used for initial beamline steering and occasional adjustments, but otherwise are not presently active in DC or AC orbit correction. For the insertion device X-BPMs, this is a consequence of systematic errors resulting from multiple sources of unwanted stray radiation striking the photoemission-sensitive X-BPM blades. This manifests itself as a “gap-dependent offset”; i.e., as the insertion device gap is changed, the relative proportion of insertion device radiation to stray radiation changes, resulting in an apparent shift in beam position. Serious efforts are under way to study methods that will reduce or eliminate these stray radiation sources. One method being studied is a small realignment of accelerator and front-end components that would redirect the majority of stray radiation away from the X-BPMs.

During studies periods, local vertical DC correction capability has been demonstrated on bending magnet beamlines using X-BPMs. These X-BPMs, which are active in the vertical plane only, do not exhibit problems with systematic errors and are the most accurate means of determining long-term vertical beam drift. They are generally used as a benchmark against which our efforts at DC beam stabilization are measured.

Implementation strategies to combine local and global DC orbit correction utilizing X-BPMs are

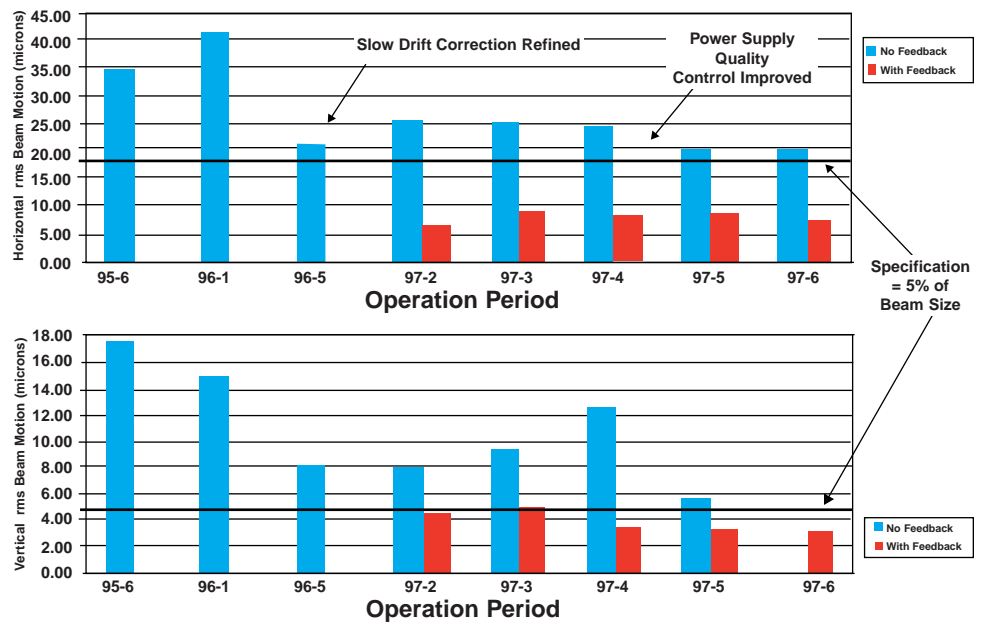

FIG. 6. APS beam stability history, 1995-present.

under investigation. Interface hardware is in place that provides all available X-BPM data to the real-time feedback system. Incorporation of this information into real-time orbit correction is proceeding in concert with efforts to understand X-BPM systematic effects and different correction algorithms.

SUMMARY

Particle beam position measurement and correction at the Advanced Photon Source are presently at the state-of-the-art for synchrotron light sources, with few-micron stability now being accomplished routinely. Upgrade efforts on the rf BPMs, the X-BPMs, and new correction algorithms provide the promise of true submicron beam stabilization in the near future. ○

REFERENCES

- 1 Y. Chung, E. Kahana, “Performance of the Beam Position Monitor for the Advanced Photon Source,” Proceedings of SRI’95, Rev. Sci. Instrum. **66** (9), September 1995 (CD-ROM).
- 2 L. Emery, “Advancements in Orbit Drift Correction in the Advanced Photon Source Storage Ring,” Proceedings of PAC’97 (to be published).
- 3 A. Ropert, ESRF, Private Communication.
- 4 J. Carwardine and F. Lenkszus, “Architecture of the APS Real-Time Orbit Feedback System,” Proceedings of ICALEPCS’97 (to be published).
- 5 G. Decker, “Performance of the Advanced Photon Source,” Proceedings of PAC’97 (to be published).